

6	1	PUZZLECUBE_PART6	ABS PLASTIC
5	1	PUZZLECUBE_PART5	ABS PLASTIC
4	1	PUZZLECUBE_PART4	ABS PLASTIC
3	1	PUZZLECUBE_PART3	ABS PLASTIC
2	1	PUZZLECUBE_PART2	ABS PLASTIC
1	1	PUZZLECUBE_PART1	ABS PLASTIC
ITEM	QTY	PART NUMBER	MATERIAL
PARTS LIST			

All units in inches. Tolerances are 0.02 inches		PROJECT		
		Intro To Engineering		
		TITLE		
		PuzzleCube_Assembly		
APPROVED	SIZE	CODE	DWG NO	REV
CHECKED	B			
DRAWN	Aditya Jain	2/11/2021	SCALE 1:2	WEIGHT
			SHEET 1/7	

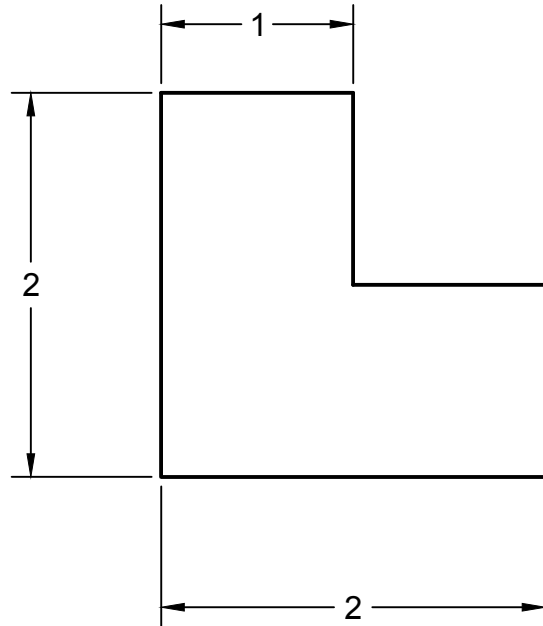

		PROJECT		
		Intro To Engineering		
		TITLE		
		PuzzleCube_Part1		
APPROVED	SIZE	CODE	DWG NO	REV
CHECKED	B			
DRAWN	Aditya Jain	2/11/2021	SCALE 1:2	WEIGHT
			SHEET 2/7	

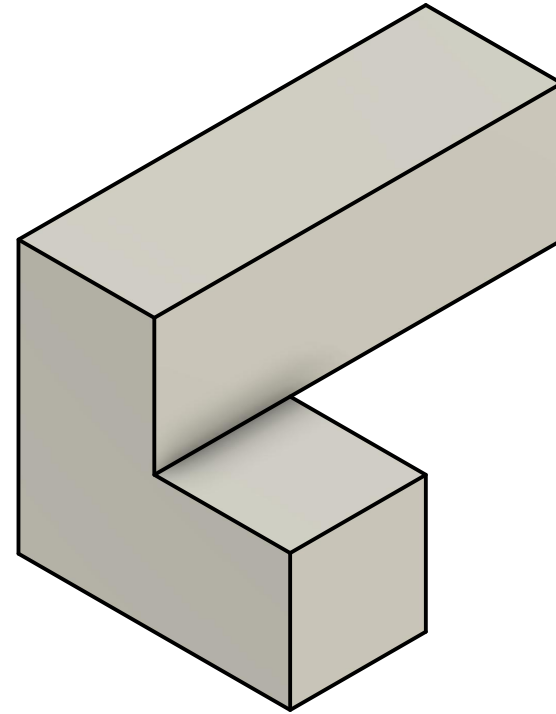
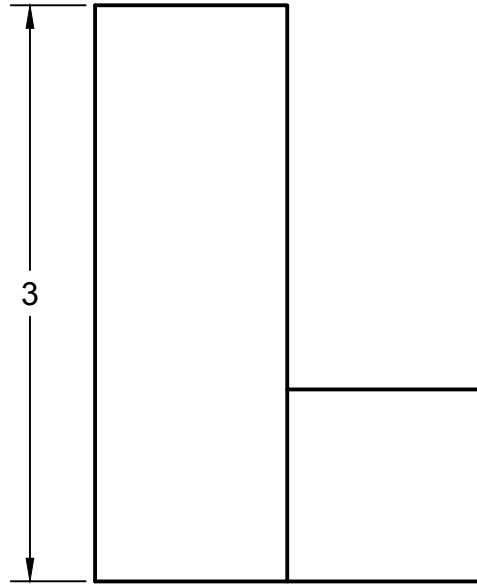
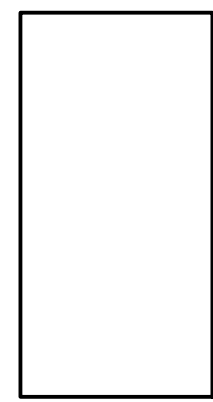
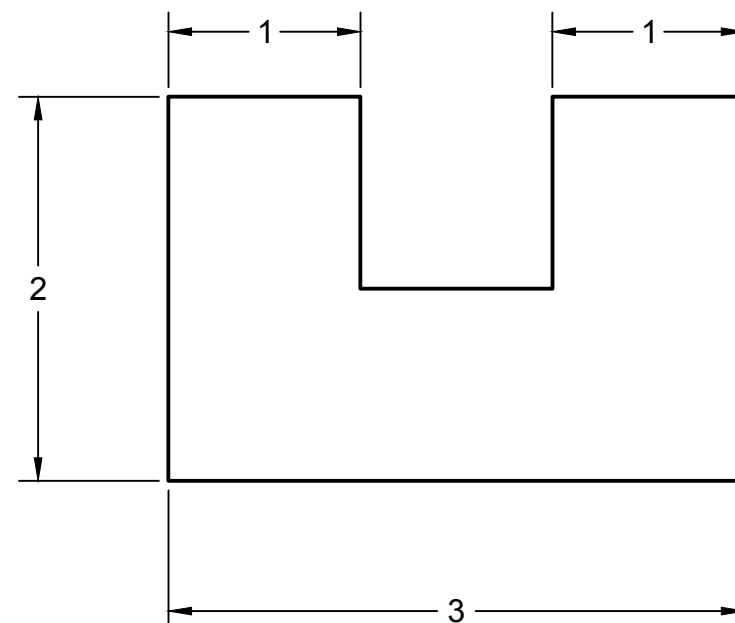
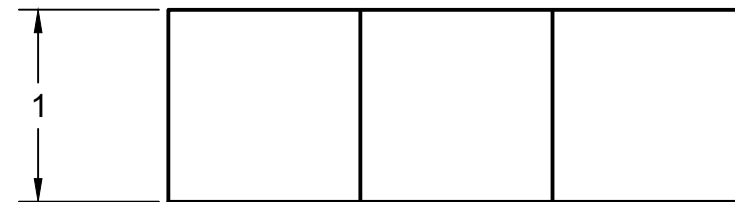
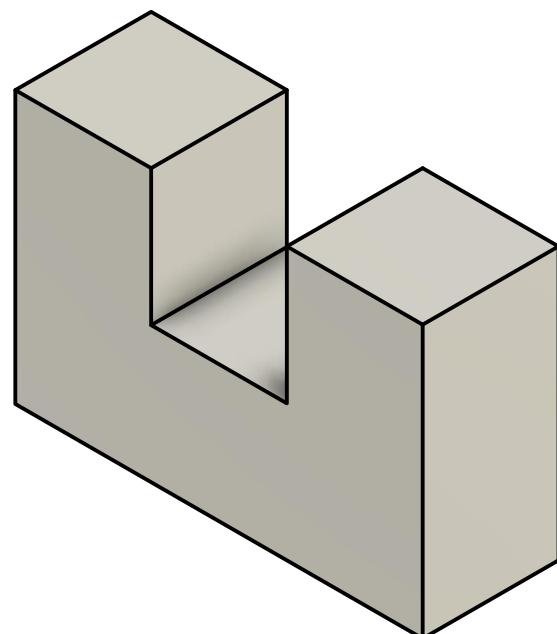

		PROJECT			
		Intro To Engineering			
		TITLE			
		PuzzleCube_Part2			
APPROVED	SIZE	CODE	DWG NO	REV	
CHECKED	B				
DRAWN	Aditya Jain	2/11/2021	SCALE 1	WEIGHT	
			SHEET 3/7		

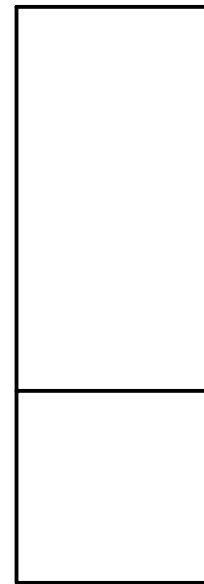
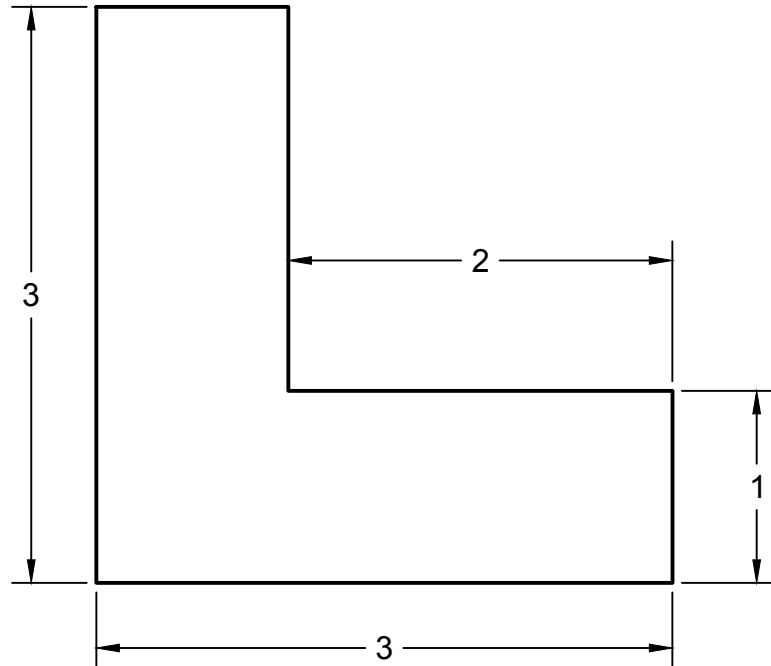
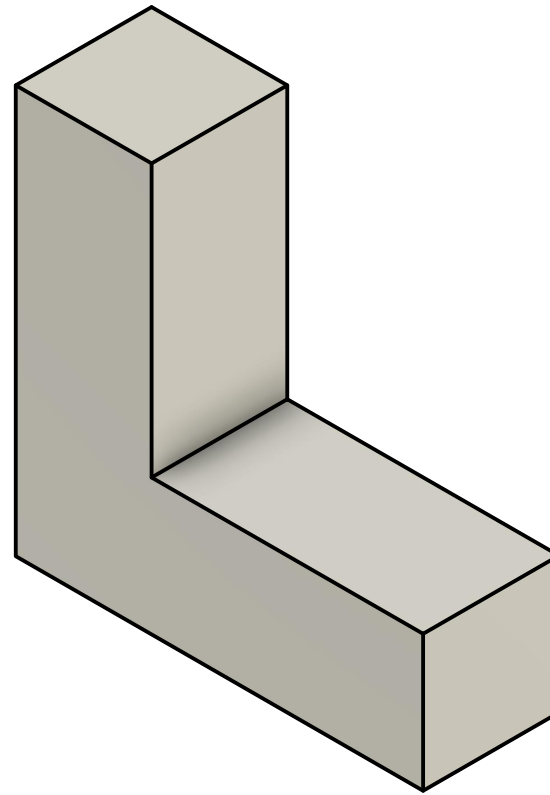
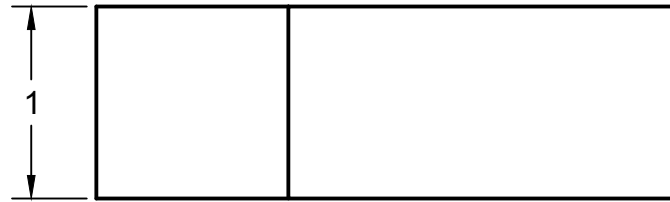

		PROJECT			
		Intro To Engineering			
		TITLE			
		PuzzleCube_Part3			
APPROVED	SIZE	CODE	DWG NO	REV	
CHECKED	B				
DRAWN	Aditya Jain	2/11/2021	SCALE 1	WEIGHT	SHEET 4/7

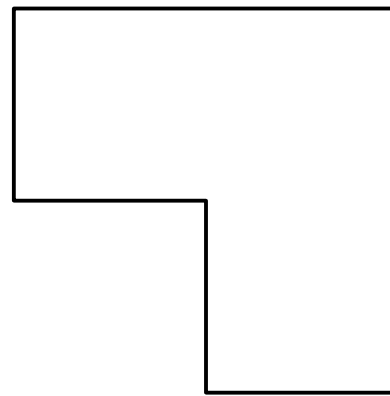
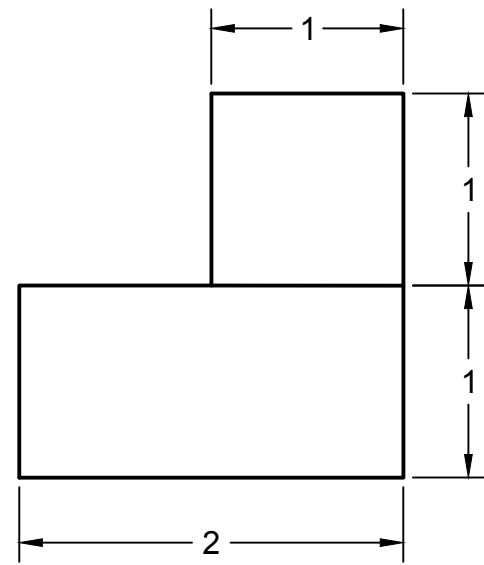
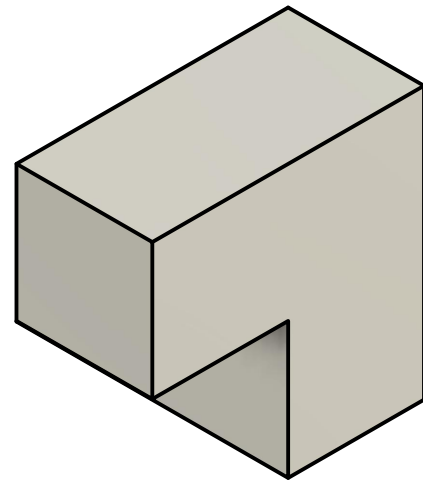
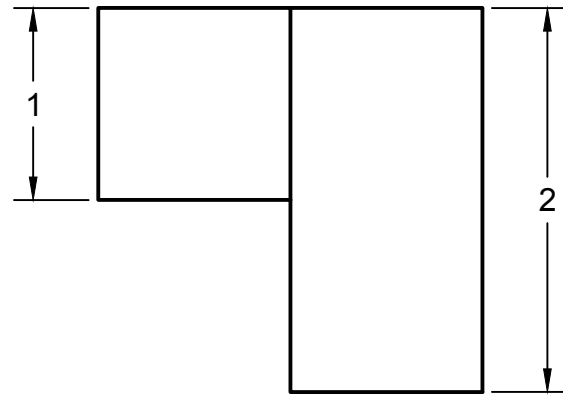

		PROJECT		
		Intro To Engineering		
		TITLE		
		PuzzleCube_Part4		
APPROVED	SIZE	CODE	DWG NO	REV
CHECKED	B			
DRAWN	Aditya Jain	2/11/2021	SCALE 1	WEIGHT
			SHEET 5/7	

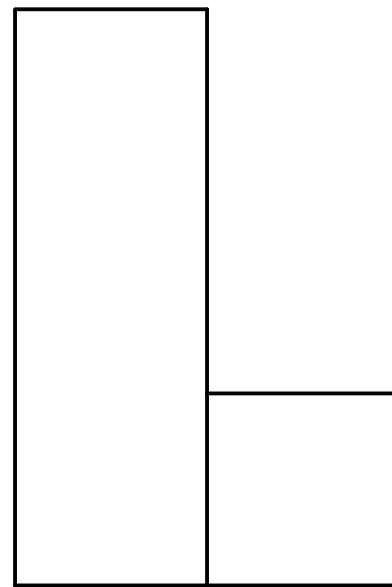
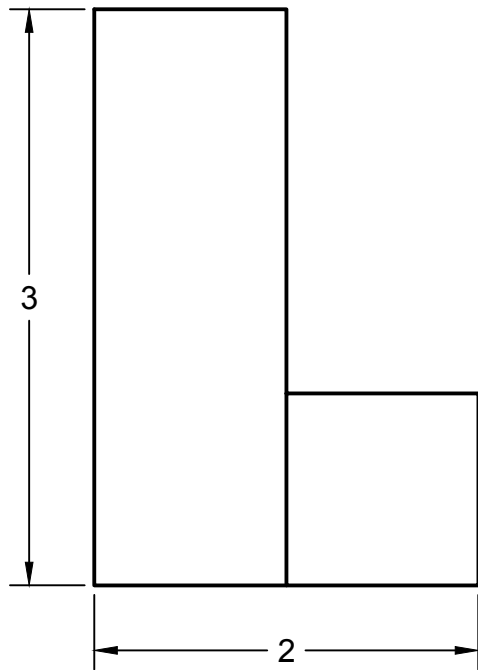
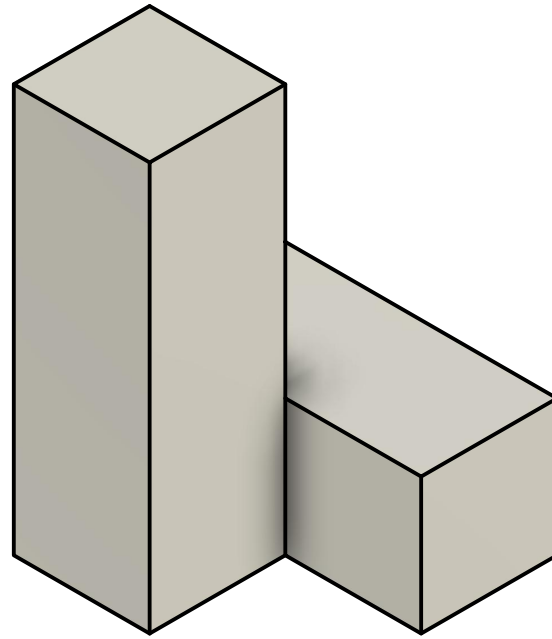
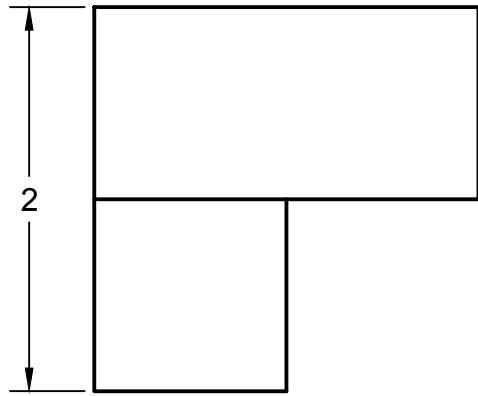

		PROJECT		
		Intro To Engineering		
		TITLE		
		PuzzleCube_Part5		
APPROVED	SIZE	CODE	DWG NO	REV
CHECKED	B			
DRAWN	Aditya Jain	2/11/2021	SCALE 1	WEIGHT
			SHEET 6/7	

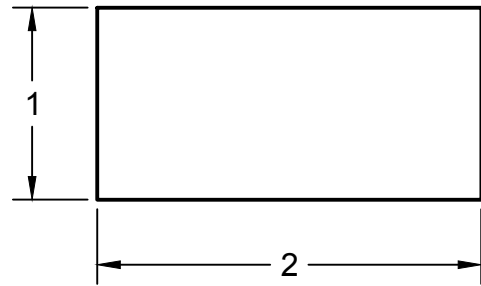
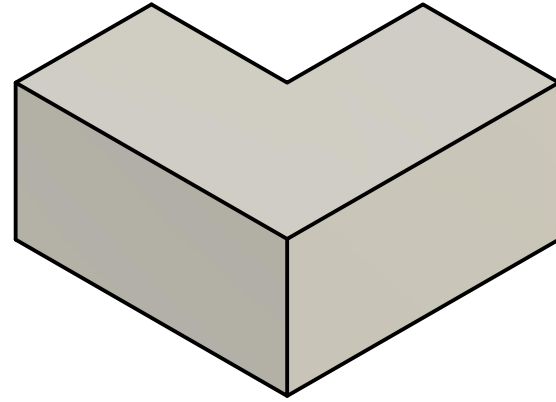
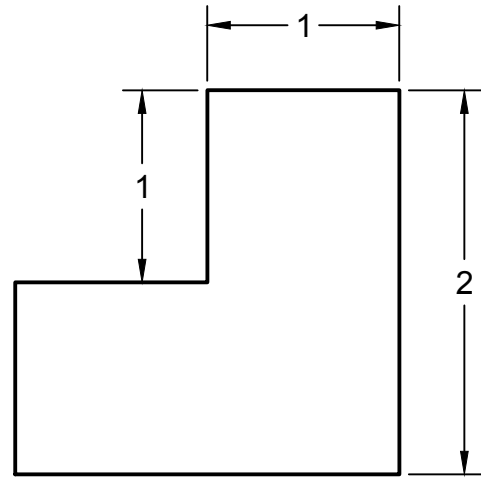

	PROJECT			
	Intro To Engineering			
	TITLE			
	PuzzleCube_Part6			
APPROVED	SIZE	CODE	DWG NO	REV
CHECKED	B			
DRAWN	Aditya Jain	2/11/2021	SCALE 1	WEIGHT
			SHEET 7/7	